

TOP VIEW
CONDITION "A"

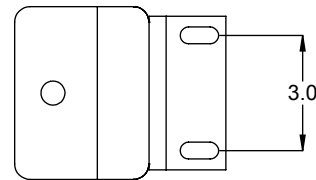

TOP VIEW
CONDITION "B"

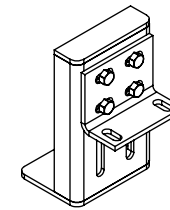

CONDITION "A"

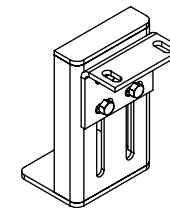
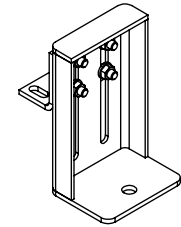

CONDITION "B"

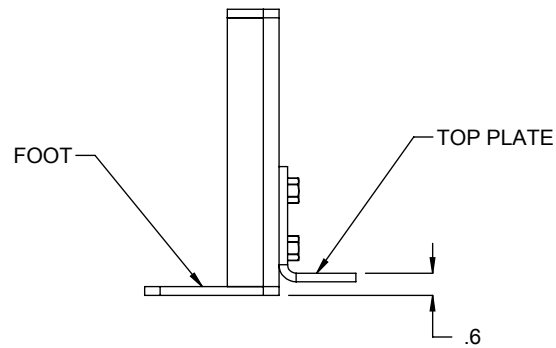
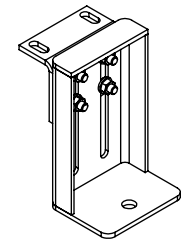

FRONT VIEW
CONDITON "A"

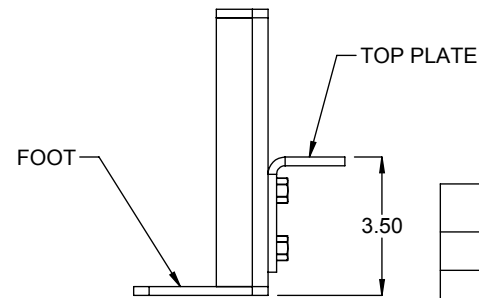

FRONT VIEW
CONDITION "B"

SPLH: HEIGHT RANGE		
MODEL	MIN.	MAX.
CONDITION "A"	0.58"	4.00"
CONDITION "B"	3.50"	7.00"

SPECIFICATIONS	
CONSTRUCTION: Steel foot, 4ga.	
TOP PLATE: <u>Standard</u> 4ga fixed top plate.	
FINISH: <u>Standard</u> finish is OSHA safety blue powder. <u>Optional</u> colors include green, beige, gray, orange, black and yellow.	

ALL PRODUCT, PRODUCT SPECIFICATIONS AND DATA ARE SUBJECT TO CHANGE WITHOUT NOTICE TO IMPROVE RELIABILITY, FUNCTION OR DESIGN OR OTHERWISE.

Model: SPLH – Support, Low Elevation, Heavy Duty

REV
0

